

Using the loan service

Introduction

The material listed in this catalogue is available for free loan to Island schools. It comprises fossils, artefacts from the past (from prehistory to the 20th century), replicas, and models. Although some of the material is boxed or displayed in portable showcases, most of the objects in the collection are intended to be handled in the classroom. Each loan is numbered: the letter B following the number indicates a showcase rather than a collection of handling material. Most of the boxes have notes which provide information on the object (s) and ideas for their use in the classroom.

The catalogue

The loans have been listed in this catalogue in chronological sections from fossils to the 20th century. This arrangement makes it relatively easy to find what is relevant to most National Curriculum history topics. However, the loans are appropriate for use across the whole curriculum.

Applying for loans

Telephone the museum (523112) with a list of your requests, or email hes@iow.gov.uk. The museum will let you know in advance what loans have been allocated to you and when to expect them in school. They will be delivered by County Transport on a Monday. Please check the numbers of the cases and boxes delivered against the delivery note which accompanies them, and let the museum know if there are any discrepancies.

Returning loans

Loans are usually booked to a teacher in a school for two and a half weeks. If you need the loans for an extended period, please telephone the museum and ask at least two days before they are due for return. We will arrange an extension provided they have not been booked by another school.

When they are due for return, the loans will be collected by us on a Thursday morning. **Please have them ready at the beginning of the day in a convenient place, with the items safely packed and checked against the contents lists. This is important: drivers don't have time to wait while boxes are packed, and loans packed in a hurry are often packed insecurely.**

The boxes and cases are returned to the museum early on Friday morning, where they are checked and repaired if necessary. Then the loans required for the Monday's delivery to schools are prepared and labelled ready for their collection by us.

Accidents

If anything is damaged or lost, please let us know at once so that we can try to arrange repair or replacement, or if necessary withdrawal from circulation. Re-pack broken objects carefully; for example, wrap fragments of glass or pottery in tissue paper.

Using the Loan Service

Fossils	1 - 2
Prehistory	3
Egyptians	4
Greeks	5
Romans	6 - 9
Saxons & Vikings	10
Middle Ages	11 - 12
Tudors & Stuarts	13 - 14
Georgians & early 19th century	15
Victorians	16 - 26
20th Century	27 - 29
Miscellaneous	30 - 32

0-228A FOSSIL COLLECTION ☺

Ammonites
Sea urchins
Lamellibranch
Brachiopod
Gastropod
Limestone
Notes

0-232A FOSSIL COLLECTION ☺

Fossilised wood
Ammonites
Sea urchin
Lamellibranch
Horse's tooth
Gastropod
'False fossil': mineral stain
on flint
Notes

0-245A FOSSIL COLLECTION ☺

Gastropods
Jet
Wood
Scaphopod
Coral
Trilobite
Nut
Shark's tooth
Sea urchin
Notes

0-258A FOSSIL COLLECTION ☺

Ammonites
Limestone pebble
Gryphaea
Shark's tooth
Fish
Sea urchin
Fragment of turtle plate
Plant impressions
Wood fragment
Gastropods
Trilobite
Notes

0-235A FOSSILISATION ☺

Fragment of turtle plate
Gastropods
Bivalve shell
Sea urchin
Ammonites
Fern
Notes

0-244A FOSSILISATION ☺

Ammonite cut to show
internal features
Ammonite (reproduction)
Fragment of turtle plate
Trilobite
Nut
Leaf impressions
Shark's tooth
Gastropods
Fish
Wood
Sea urchin
Notes

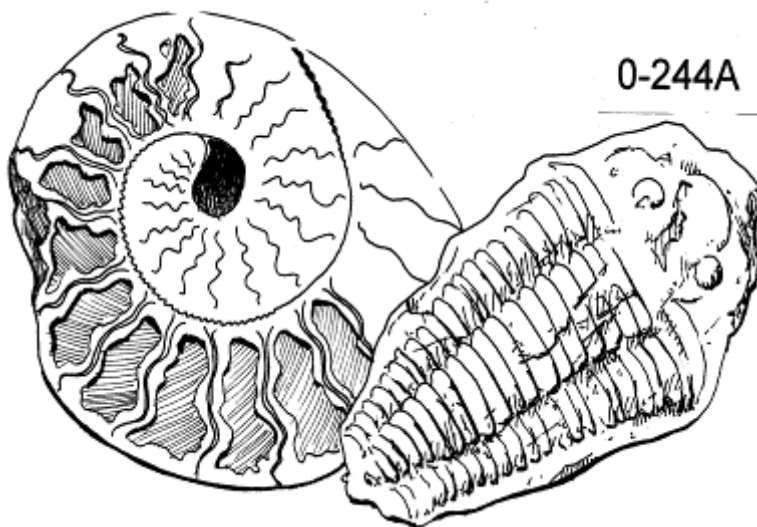

Fossils

0-234A AMMONITES ☺

Ammonites: different sizes and features
Notes

0-242A AMMONITES

Ammonites: different sizes and features
Ammonite cut to show internal features
Notes

0-243A AMMONITES ☺

Ammonites
Ammonite cut to show internal features
Notes

0-229A FOSSIL SEA URCHINS ☺

Seven examples, varying sizes and condition
Notes

0-13A FOSSIL DINOSAUR BONES ☺

Four fossil bones of iguanodon
Illustrations

0-233A FOSSIL ELEPHANT'S TOOTH ☺

Fossilised tooth
Notes

0-236A FOSSIL ELEPHANT'S TOOTH ☺

Fossilised tooth
Notes

0-241A PLANT FOSSILS

30 small plant fossils
(Carboniferous)
Notes

0-231A MINERALS

Fluorspar
Calcite
Marcasite
Malachite
Iron pyrites
Quartz
Gallena
Notes

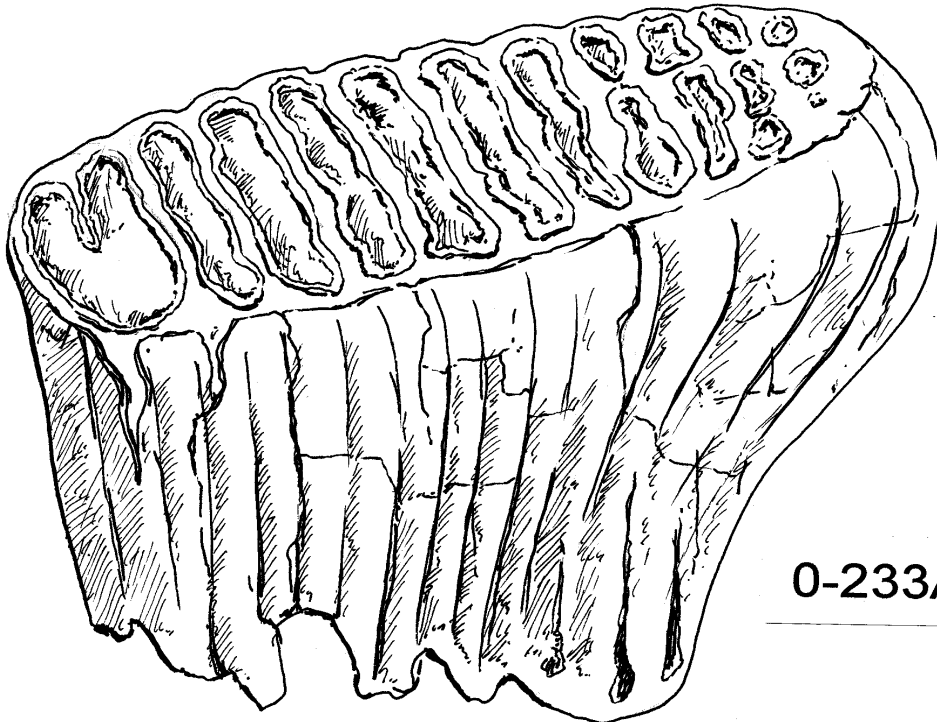

0-233A

1-100A FLINT IMPLEMENTS

Flint flake
Hammer-stone
Core
Hand-axe
Tranchet axe-head
Polished axe-head
Tranchet arrowhead
Leaf-shaped arrowhead
Microlith
Scrapers
Knife
Borer
Notes and illustrations

1-101A IW FLINT IMPLEMENTS

A 17 flint implements found on the Isle of Wight with ID sheets
24 Flint tools to sort and identify
Flint core showing scars where blades have been removed
3 Replica hafted axes
Book: Nature and subsequent uses of flint
Video: Grimes Grave

1-02A DAILY LIFE IN THE NEOLITHIC

Replica pot (based on one found in Orkney)
Antler bead
Bone needle
4 sherds of treated pottery
Replica spindle and antler whorl strung with flax
Piece of linen cloth made from Handspun flax dyed with sloe
Slippers made by the ancient Technique of 'nahlebunden'
Various samples of netting, string and rope made from different natural fibres
Sample of unspun flax
Sample of Emmer (ancient wheat)
Book: Guide book to Skara Brae

1-103A OTZI THE MAN IN THE ICE

Action man Otzi

Book: The Man in the Ice by Konrad Spindler
Replicas of some of Otzi's equipment

1-22A THE BRONZE AGE ☺

Bronze axe-head (replica)
Flint arrowhead
Flint borer
Flint knife
Fragment of large collared urn
Reproduction of small collared urn
Notes



1-46A BRONZE AGE AXES

Flat axe (genuine)
Flanged axe (replica)
Palstave (replica)
Socketed axe (replica)
(These show the development of the axe)
Two-part mould for an axe-head (replica)

Egyptians

11-273C ANCIENT EGYPTIAN MAN
Costume model

11-274C ANCIENT EGYPTIAN WOMAN
Costume model

**11-112A ANCIENT EGYPT:
PERSONAL OBJECTS**

Bead necklace
Small heart-shaped
amulet
Small faience pot
Menat (replica)
Ibex cosmetic knife (replica)
Hair curler "
Thimble "
Shell ornament (reproduction)
Bead necklace "
Notes

11-354A

11-353A ANCIENT EGYPTIAN POT
Notes

**11-354A ANCIENT EGYPT: PREPARING
FOR THE AFTER-LIFE**

Four models showing the process
of mummification
Two ushabtis
Stone from a pyramid
Evening Standard souvenir
newspaper of the Tutankhamun
exhibition (Sat. 6 May 1972)
Copy of a fragment of wall-
painting from a tomb
Ushabti (reproduction)
Heart scarab "
Notes

11-355A ANCIENT EGYPT: ANIMALS

Fly amulet
Hippo (reproduction)
Cat goddess "
Hedgehog "
Jerboa "
Notes



2-128A GREEK POTTERY

Lekythos
Oil bottle (replica)
Scent bottle "
Notes

2-293A GREEK POTTERY

Bottle
Small jar
Trinket pot (replica)
Lamp "
Notes

2-294A GREEK POTTERY

Lekythos
Small bottle
Drinking-cup (replica)
Wine jug "
Notes

2-306A GREEK POT

Lekythos
Notes

2-284C GREEK MAN

Costume model

2-285C GREEK WOMAN

Costume model

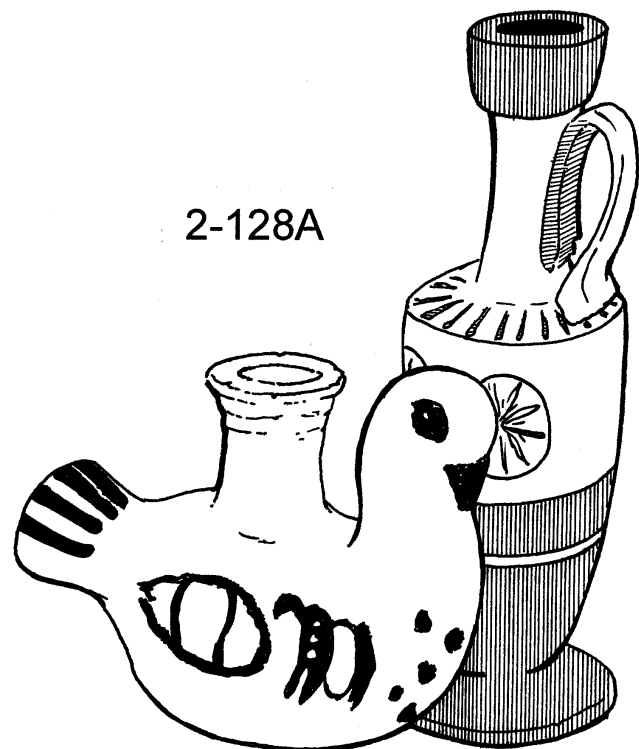

2-1A THE ROMANS

Mosaic fragment
Tesserae
Nail
Plaster fragment
Pottery fragments
Oyster shell
Bronze spoon
Bone hairpin
Fragment of box flue-tile
Coin lamp (reproduction)
Brooch "
Key "
Notes

2-12A THE ROMANS

Mosaic fragment
Tesserae
Nail
Plaster fragment
Pottery fragments
Oyster shell
Fragment of box flue-tile
Coin (reproduction)
Plaque "
Brooch "
Oil lamp "
Spoon "
Notes

2-299A ROMAN COLLECTION ☺

Tesserae
Plaster fragment
Pottery fragments
Fragment of box flue-tile
Oil lamp
Kitchen waste (bone, tooth, shell)
Coin
Glass fragment
Bracelet
Brooch (reproduction)
Coin "
Notes

2-300A ROMAN COLLECTION ☺

Tesserae
Plaster fragment
Oil lamp
Pottery fragment
Kitchen waste (bone, tooth, shell, antler)
Glass fragment
Spoon (reproduction)
Brooch "
Stylus "
Mouse ornament "
Coin "
Oil lamp "
Notes

2-165A THE ROMANS ☺

Oil lamp
Mosaic fragment
Tesserae
Pottery fragments
Kitchen waste (bone, tooth, shell)
Spindle whorl
Dress pin
Tweezers
Samian dish (replica)
Spoon (reproduction)
'Dice pot' "
Medusa pendant "
Notes

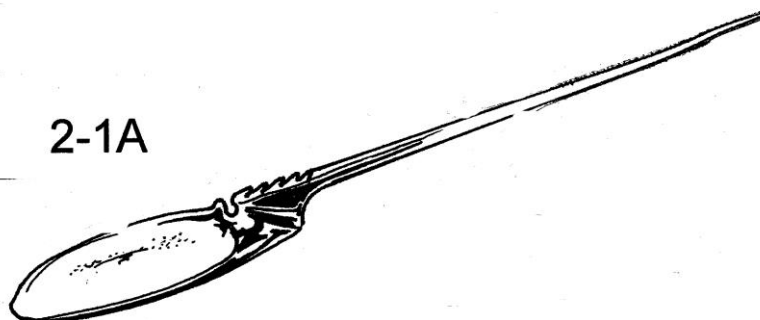

1-143C CELTIC MAN

Costume model

1-144C CELTIC WOMAN

Costume model

2-147C ROMAN MAN

Costume model

2-148C ROMAN WOMAN

Costume model

2-268C ROMAN MAN

Costume model

2-269C ROMAN WOMAN

Costume model

2-8A TOGA

Toga

Notes & instructions

2-266A CHILD'S TOGA ☺

Toga to fit boy in year 3 or 4

Notes

Instructions

2-267A CHILD'S TOGA ☺

Toga to fit boy in year 3 or 4

Notes

Instructions

2-213A ROMAN POTTERY

13 assorted pottery fragments
including rims and bases

Notes and pictures etc

2-223A ROMAN POTTERY

10 assorted pottery fragments
including rims and bases

Notes and pictures etc

2-252A ROMAN POTTERY

14 assorted pottery fragments
including rims and bases

Notes and pictures etc

2-280A SAMIAN POTTERY

Replica Samian bowl

Genuine pottery fragments

Replica fragments (to piece
together)

Coins

Picture

Notes

2-281A ROMAN KITCHEN POTTERY

Pottery fragments

Mortarium (reproduction)

Notes

2-395A ROMANO-BRITISH CLOTHING

Linen tunic & tie

Wool tunic & tie

Scarf

Cloak (byrrus Britannicus)

Gallic cloak

Sandals

Notes

2-396A ROMAN MEDICAL EQUIPMENT

Cataract needle

Crown trephine and bow

Bone lever

Hook

Medical spoon

Probe

Spoon probe

Saw

Scalpel

Ligula

Spatul

Notes

2-215A OIL LAMPS

Four genuine pottery oil lamps
Reproduction oil lamp
Notes

2-238A ROMAN OIL LAMPS

Four genuine pottery oil lamps
Reproduction oil lamp
Notes

2-9A ROMAN LAMP AND WRITING MATERIALS ☺

Pottery lamp
Pottery lamp (reproduction)
Wax-coated wooden writing tablet (reproduction)
Stylus "
Notes

2-49C CONSTRUCTION OF A ROMAN ROAD ☺

Model showing Roman soldiers in process of building a road, on base 60 x 45 cm, under Perspex

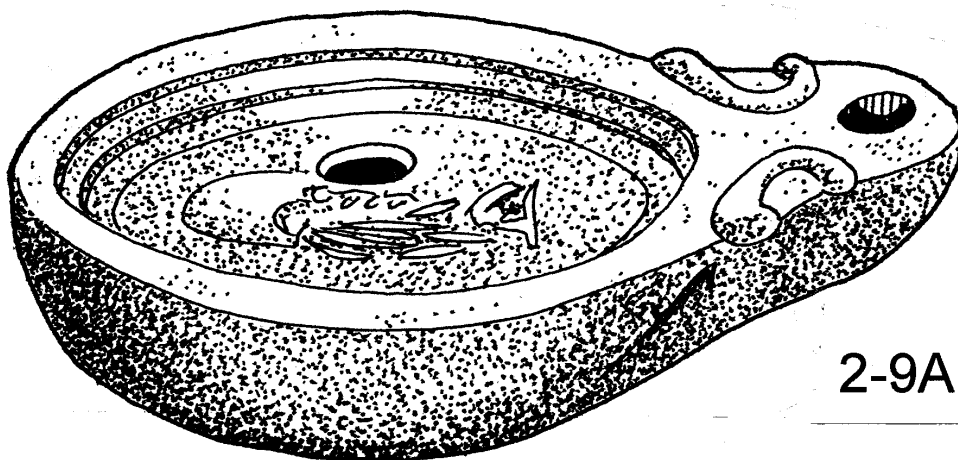

2-9A

Saxons and Vikings

3-42A THE ANGLO-SAXONS

Fragment of pottery
Brooch
Pot (reproduction)
Bottle "
Bowl "
Lamp "
Four brooches "
Double twist ring "
Two Saxon coins "
Franks casket "
Piece of mail (replica)
Notes



3-84C ANGLO-SAXON LORD

Costume model

3-85C ANGLO-SAXON LADY

Costume model

3-118C ANGLO-SAXON PEASANT MAN

Costume model

3-119C ANGLO-SAXON PEASANT WOMAN

Costume model

3-261B ANGLO-SAXON BURIAL

Model of Victorian excavation of
Anglo-Saxon burial
Notes

3-296A ANGLO-SAXON POT

Pot (replica)
Notes

3-371A ANGLO-SAXON POT

Same as 3-296A

3-401A ANGLO-SAXONS GAMES - HNEFATAFL

15 leather boards and counters.
Notes

3-402A ANGLO-SAXON GAMES – NINE MEN'S MORRIS

15 leather boards and counters
Notes

3-403A REPLICA IW SAXON SKILLET

Fragment of pottery

3-203A VIKING SHIP

Viking ship model

4-192C NORMAN KNIGHT
Costume model

4-57D THE BAYEUX TAPESTRY
Set of 12 slides
Notes

4-75A MAIL ☺
Mail coif (modern)
Piece of riveted mail (replica)
Five arrowheads (replica)
Picture
Notes

4-67C NORMAN LORD
Costume model

4-68C NORMAN LADY
Costume model

4-136C SIEGE TOWER
Model
Notes

4-137C BATTERING RAM
Model
Notes

4-138C CAT OR SOW
Model
Notes

4-139C MANGONEL
Model
Notes

4-140C TREBUCHET
Model
Notes

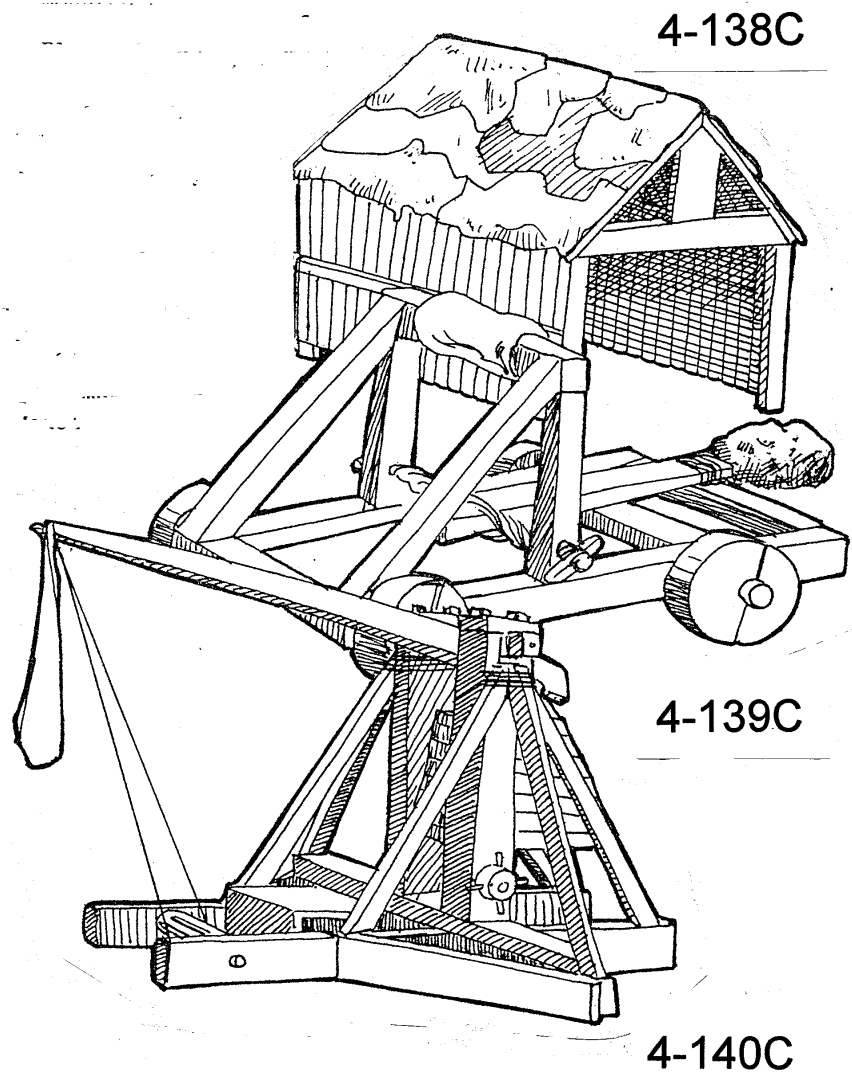

Middle Ages

4-216C LORD 1300
Costume model

4-217C LADY 1300
Costume model

4-69C 14TH-CENTURY LORD
Costume model

4-70C 14TH-CENTURY LADY
Costume model

4-189C MEDIEVAL MINSTREL
Costume model

4-190C MEDIEVAL MERCHANT
Costume model

4-191C MEDIEVAL MONK
Costume model

4-55C MEDIEVAL PEASANT WOMAN
Costume model

4-56C MEDIEVAL PEASANT MAN
Costume model

4-18D COUNTRY LIFE IN THE MIDDLE AGES
Set of 12 slides of pictures from medieval manuscripts
Notes

4-19D COUNTRY LIFE IN THE MIDDLE AGES
Set of 36 slides of pictures from medieval manuscripts
Notes

4-276A MEDIEVAL JUGS
13th-century wine jug (replica)
Puzzle jug (replica)
Notes

4-295A MEDIEVAL JUG
Baluster jug (replica)
Notes

4-298A AQUAMANILE
Aquamanile (replica of jug in form of knight on horseback)
Notes

4-221A ALEMBIC
Vessel for purifying water (replica)
Notes

4-277A MEDIEVAL TILES
13th-century tile (incomplete)
Four patterned tiles (reproduction)
Notes

4-356A MEDIEVAL LIFE ☺
Part of roof-tile
Fragment of cooking-pot
Candle holder (reproduction)
Thimble "
Four coins "
Bracelet "
Key "
Spoon "

4-390A MEDIEVAL LANTERNS
15th C. Tankard lantern (repro)
14th C. Lantern (replica of lantern in Mus. of London)

6-239A LANTERN AND JUG ☺

Horn lantern (replica)
 Blackjack "
 Notes

6-264A CANDLE-HOLDERS

Wrought-iron candelabrum
 Wrought-iron floor standard
 Notes

5-330A TUDOR TOYS ☺

Cup and ball (reproduction)
 Lenten rattle "
 Whip and top "
 Two streamers "
 String-driven mill "
 Five stones "
 Notes

5-337A TUDORS: HOME LIFE ☺

Inkwell (replica)
 Pounce pot "
 Quill pen "
 Oil lamp "
 Pipkin "
 Jug "
 Watering pot "
 Notes

6-301A PEWTERWARE ☺

Pewter plate (reproduction)
 Spoon "
 Candlestick "
 Notes

6-41A 17TH-CENTURY LIFE ☺

Bellarmino jug
 Four buttons
 Drawer handle
 Piece of embroidered bed-
 hanging ca. 1670
 Pot (incomplete)
 Charles II's seal (replica)
 Notes

5-368A TUDOR LIGHTING

Oil lamp (reproduction)
 Pottery candlestick "
 Rushlight holder & candlestick "
 Notes

5-361A TUDOR MEALS:

PREPARATION AND SERVING ☺

Fragment of dish
 Wooden trencher (replica)
 Pipkin "
 Spoon "
 Horn beaker "
 Wooden bowl "
 Jug "
 Pottery beaker "
 Notes

5-369A TUDORS: ITEMS FOR THE RICH

Bronze buckle
 Elizabeth I sovereign (repro)
 Money box "
 Four coins "
 Thimble "
 Pomander "
 Scent bottle "
 Pattens "
 Horn book "
 Quill pen (replica)
 Picture (master & schoolboy)
 Notes

5-373A SALT GLAZED POTTERY

Fragment of Bellarmine jug
 Bellarmine jug (reproduction)
 Tankard "
 Notes



Tudors and Stuarts

6-37A CIVIL WAR WEAPONS

Basket-hilted broadsword
(reproduction)

Rapier "

Notes

6-23A(1&2) CIVIL WAR HELMETS ☺

Lobster-tail helmet (reproduction)

Pikeman's helmet "

Pictures

Notes

6-290A BOY'S COSTUME 1640s ☺

Complete reproduction middle-
class outfit for year 5 boy

Notes

6-291A GIRL'S COSTUME 1640s ☺

Complete reproduction middle-
class outfit for year 5 girl

Notes

5-120C FASHION 1500 (MAN)

Costume model

5-121C FASHION 1500 (WOMAN)

Costume model

5-169C FASHION 1545 (MAN)

Costume model

5-170C FASHION 1545 (WOMAN)

Costume model

5-82C FASHION 1588 (MAN)

Costume model

5-83C FASHION 1588 (WOMAN)

Costume model

5-145C TUDOR PEASANT (MAN)

Costume model

5-146C TUDOR PEASANT (WOMAN)

Costume model

5-131C WATER CARRIER 1540

Costume model

6-61C CAVALIER

Costume model

6-76C FASHION 1640 (WOMAN)

Costume model

6-59C PURITAN MAN

Costume model

6-60C PURITAN WOMAN

Costume model

6-198C CIVIL WAR MUSKETEER

Costume model

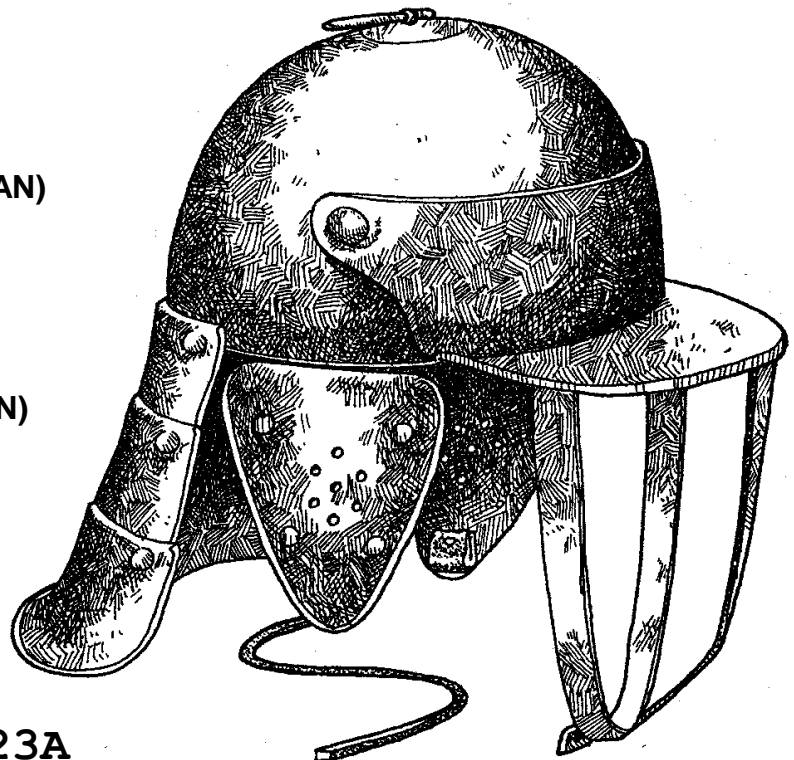

6-23A

18th and early 19th centuries

7-78C FASHION 1750 (MAN)

Costume model

7-79C FASHION 1750 (WOMAN)

Costume model

8-168B REGENCY COSTUME

Pink silk brocade spencer

Pair of indoor shoes

Notes

8-133C FASHION 1825 (MAN)

Costume model

8-134C FASHION 1825 (WOMAN)

Costume model

7-132C 'BLUE JENNY' 1760

Costume model

78-63A LIGHTING:

18TH & 19TH CENTURIES ☺

Rushlight holder

Candle holder & tinder box

Candle holder

Candle mould

Notes

8-202C SAILOR (NAPOLEONIC WARS)

Costume model

7-256A SMUGGLING ☺

Brandy keg

Grappling hook

Notes

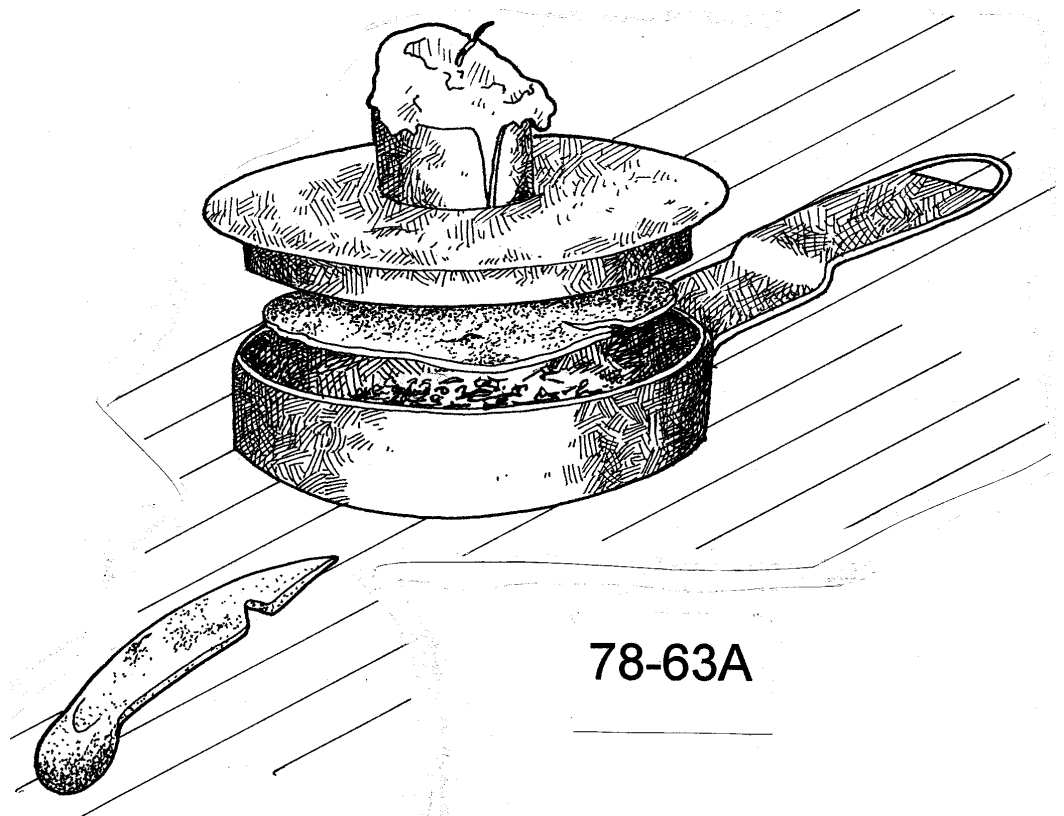

78-63A

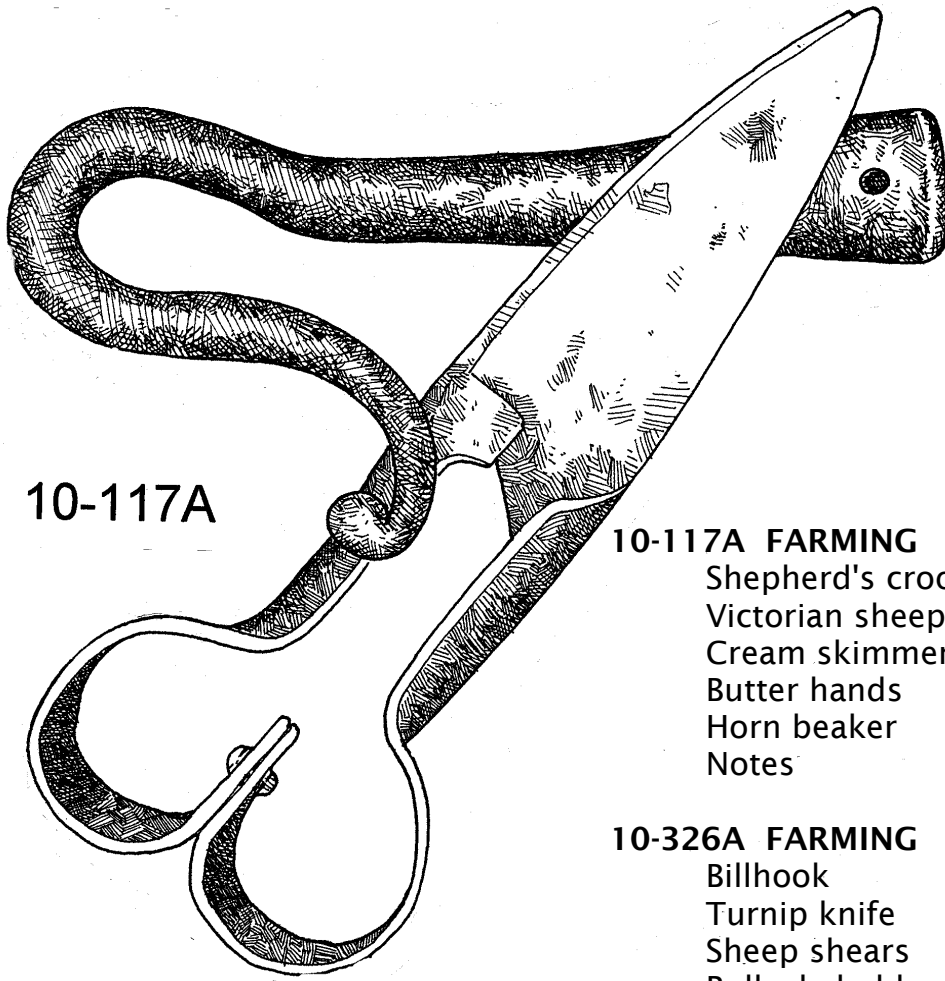

10-117A

10-117A FARMING
Shepherd's crook
Victorian sheep shears
Cream skimmer
Butter hands
Horn beaker
Notes

10-326A FARMING
Billhook
Turnip knife
Sheep shears
Bullock- holder
Bird- scarer
Notes

8-135C LONGSHOREMAN
Costume model

8-26C AGRICULTURAL LABOURER
Costume model

10-260A FARMING
Billhook
Sheep shears
Animal- feed scoop
Notes

8-27C MILKMAID
Costume model

8-211A YOKE ☺
Yoke for carrying buckets

10-327A THE DAIRY
Skimmer
Scotch hands
Butter stamp
Milk measure
Notes

8-178A STABLE LANTERN ☺
Stable lantern
Notes

8-303A COSTREL ☺
Costrel (drinking flask)
Notes

8-102A ROASTING JACK

Bottle- jack for roasting
Key
Notes and instructions

8-105A ROASTING JACK

Bottle- jack for roasting
Key
Notes and instructions

8-174A GRID IRON ☺

Grid- iron with drip trough
Notes

8-90A SAUCEPANS ☺

Early- 19th- century tinker- made
copper saucepan
Late- 19th- century bell- metal
saucepan
Notes

8-92A SKILLET ☺

Iron skillet pan with handle for
hanging over fire
Notes

89-352A COPPER KETTLE ☺

8-127A KITCHEN EQUIPMENT ☺

Bread mould
Cake mould
Patty tins
Pastry cutter
Pastry wheel
Sugar nippers
Tin opener
Notes

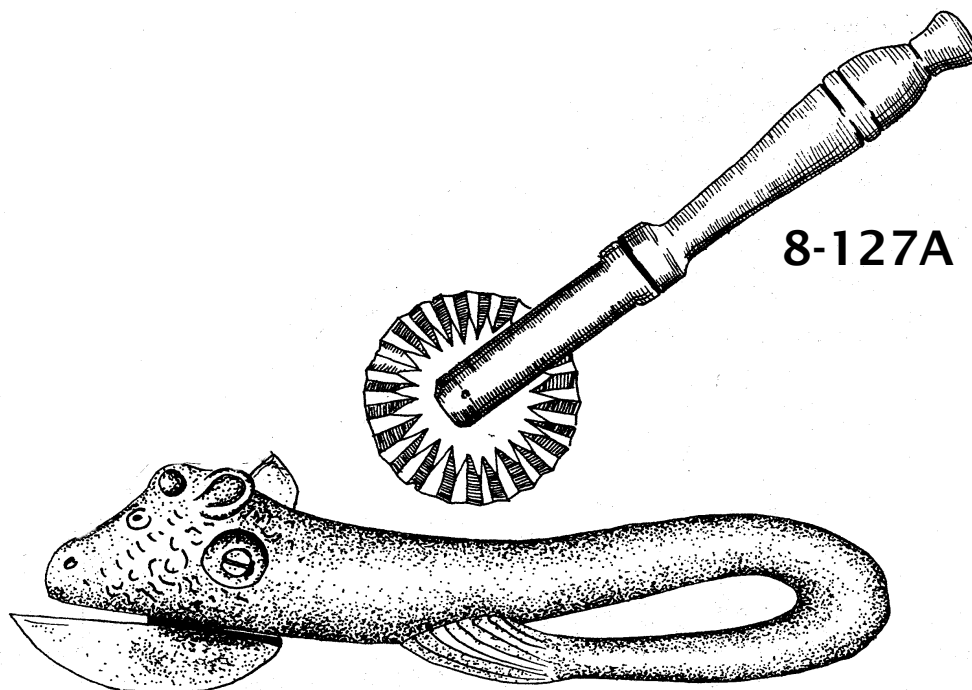

8-127A

8-89A VICTORIAN KITCHEN EQUIPMENT ☺

Copper jelly mould (1840)
Two china moulds
Rolling pin
Mrs Beeton's Book of Household Management (facsimile)

8-107A FOOD CHOPPER ☺

Food chopper
Attachments
Notes

8-237A FOOD CHOPPER ☺

Food chopper (mincer)
Notes

8-187A FOOD CHOPPER ☺

'New Standard' food chopper made in USA (improved version of 8- 107A)
Notes

8-312A SAUSAGE-MAKING MACHINE

Sausage- making machine ☺
Notes

8-314A COFFEE MILL ☺

Coffee mill
Notes

8-32A CAKE-MIXER (1896) ☺

Tin
Clamp
Mixing mechanism
Notes

8-160A MARMALADE CUTTER ☺

Marmalade cutter
Notes

8-188A KITCHEN EQUIPMENT ☺

Gingerbread mould
Nutmeg grater
Notes

8-179A KNIFE CLEANER

Rotary knife cleaner
Notes

8-248A VICTORIAN WALL TILES

Two transfer- printed wall tiles
Three embossed wall tiles
Notes

8-24C MUFFIN MAN

Costume model

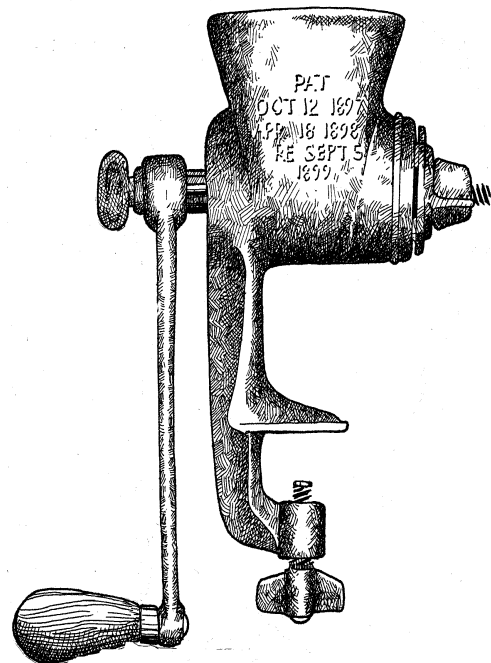

8-107A

8-28C PARLOURMAID

Costume model

78-63A LIGHTING:

18TH & 19TH CENTURIES ☺

Candle holder & tinder box

Candle snuffer

Candle mould

Rushlight holder (replica)

Notes

8-302A LIGHTING

Candle holder

Candle mould

Candle snuffer

Notes

8-335A BULL'S EYE LANTERN

Bull's eye lantern

Notes

8-207A LIGHTING: OIL LAMPS

Crusie lamp

Tin- miner's oil lamp

Wick trimmer

Match holder

Notes

8-104A FOOT WARMER ☺

Notes

8-289A FOOT WARMER ☺

Notes

8-181A HOT WATER CAN

Notes

8-333A HOT WATER CAN

Notes

8-64C FASHION 1860 (MAN)

Costume model

8-65C FASHION 1860 (WOMAN)

Costume model

8-80C FASHION 1875 (MAN)

Costume model

8-81C FASHION 1875 (WOMAN)

Costume model

8-305A VICTORIAN DRESS

Victorian dress from 1860s
Notes

**8-310A VICTORIAN CRINOLINE
GOWN (reproduction)**

Chemise
Camisole
Drawers
Crinoline
Petticoat
Gown
Notes

8-227A VICTORIAN GARMENTS

Lady's cotton blouse
Lady's velvet bodice
Man's waistcoat
Notes

8-108A BUSTLE DRESS

Countrywoman's bustle dress
(reproduction)
Notes

8-177A VICTORIAN UNDERWEAR

Chemise
Corset
Camisole
Drawers
Combinations
Flannel bodice
Silk petticoat
Flannel petticoat
Nightdress
Nightcap
Feature from The Girl's Own
Paper, 1899 (photocopy)
Notes

8-101A VICTORIAN UNDERWEAR

Silk petticoat
Flannel petticoat
Drawers
Pair of combinations
Nightdress
Feature from The Girl's Own
Paper, 1899, (photocopy)
Notes

89-176A CHILDREN'S CLOTHES ☺

Cotton dress
Silk dress
Drawers
Boy's shirt
Girl's pinafore (reproduction)
Notes

**8-106A VICTORIAN BABIES'
CLOTHES ☺**

Two gowns
Petticoat
Bonnet
Flannel bodice
Shirt
Carrying- cloak
Notes

8-182B VICTORIAN ACCESSORIES ☺

Chenille cloak
Lace collar
Mittens
Evening slippers
Velvet bonnet

8-95B VICTORIAN ACCESSORIES ☺

White kid evening gloves
White lace and ivory fan
Tortoise- shell comb
Hat pins
Tapestry bag
Bead purse
Black lace scarf

8-73A VICTORIAN PERSONAL OBJECTS ☺

Ostrich- feather fan
Jet decoration
Beaded drawstring bag
Leather purse
Stocking purse
Pince- nez
Magnifier
Button hook
Skirt lifter
Rouge pot
Chatelaine pencil
Lady's watch
Watch- chain
Watch- chain ornament
Vesta (match- box)
Notes

8-125B PERSONAL ITEMS (VICTORIAN & EDWARDIAN)

Hair curlers
Fan
Cut- throat razor
Amber cigar- holder with case
A 'lady's companion'
Handbag
Sovereign purse
Pair of tortoise- shell- rimmed spectacles with case
Stylograph
Notes

8-113A BOOT AND GLOVE ACCESSORIES ☺

Boot jack
Boot hook
Button hook
Shoe trees
Glove stretcher
Notes

8-212A SHOE AND GLOVE ACCESSORIES ☺

Pair of shoe trees
Button hook
Glove stretchers
Notes

8-175A HAT STRETCHER

8-161A SEWING MACHINE ☺

Small Victorian sewing machine
Notes

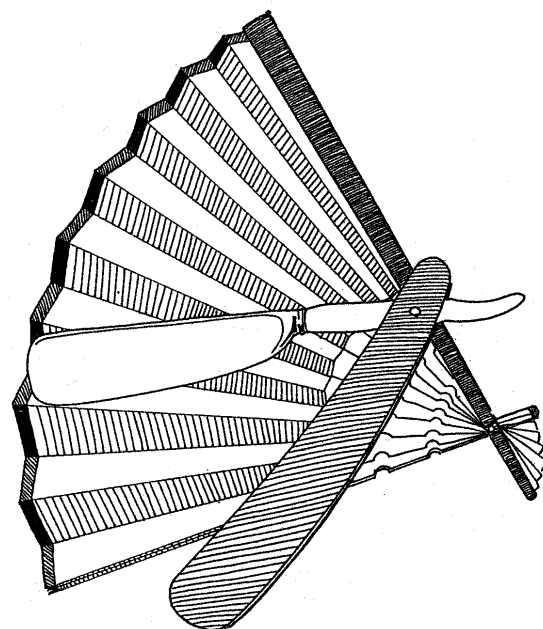

8-125B

8-200C VICTORIAN WASHERWOMAN

Costume model

89-33A WASH-DAY ☺

Soap- grater
Wash- dolly
Posser
Wash- boards
Tongs
Clothes- pegs
Notes

89-311A WASH-DAY ☺

Soap- grater
Wash- dolly
Posser
Wash- board
Tongs
Clothes- pegs
Notes

89-331A WASH-DAY ☺

Wash- board
Wash- dolly
Baby posser
Wash- tongs
Clothes- pegs
Notes

8-99A IRONS ☺

Flat- iron
Stand
Charcoal iron
Notes

8-98A IRONS ☺

Charcoal iron
Box- iron with slug
Notes

8-111A IRONS ☺

Italian iron
Gauffering iron
Polishing iron
Miniature flat- iron and stand
Notes

8-153A IRONS ☺

Italian iron with rod
Box- iron with iron slug
Iron with bar cavity
Notes

8-167A GOOSE IRON ☺

Iron used by tailors
Notes

89-362A IRONS ☺

Spirit iron
Electric iron
Notes

8-363A IRONS ☺

Sad iron
Box- iron
Small flat- iron
Notes

8-364A IRONS: MRS POTTS'S IRONS ☺

Mrs Potts's box- iron
Mrs Potts's iron: detachable
handle & base
Mrs Potts's iron: base
Notes

8-365A IRONS ☺

(for special purposes)

Three hatter's irons
Polishing iron
Fluting iron
Italian iron
Notes

8-366A CHARCOAL IRONS ☺

Large charcoal iron with chimney
Small charcoal iron
Notes

8-151C TENNIS PLAYER 1870
Costume model

8-152C CRICKETER 1840
Costume model

**8-171C VICTORIAN SWIMMING
COSTUME**
Costume model

8-149C CYCLIST 1890 (MAN)
Costume model

8-150C CYCLIST 1895 (WOMAN)
Costume model

8-201C VICTORIAN BOBBY
Costume model

8-11A LAW AND ORDER ☺
Truncheon
Policeman's lamp
Handcuffs
Knuckleduster

8-25C RAILWAY NAVVY
Costume model

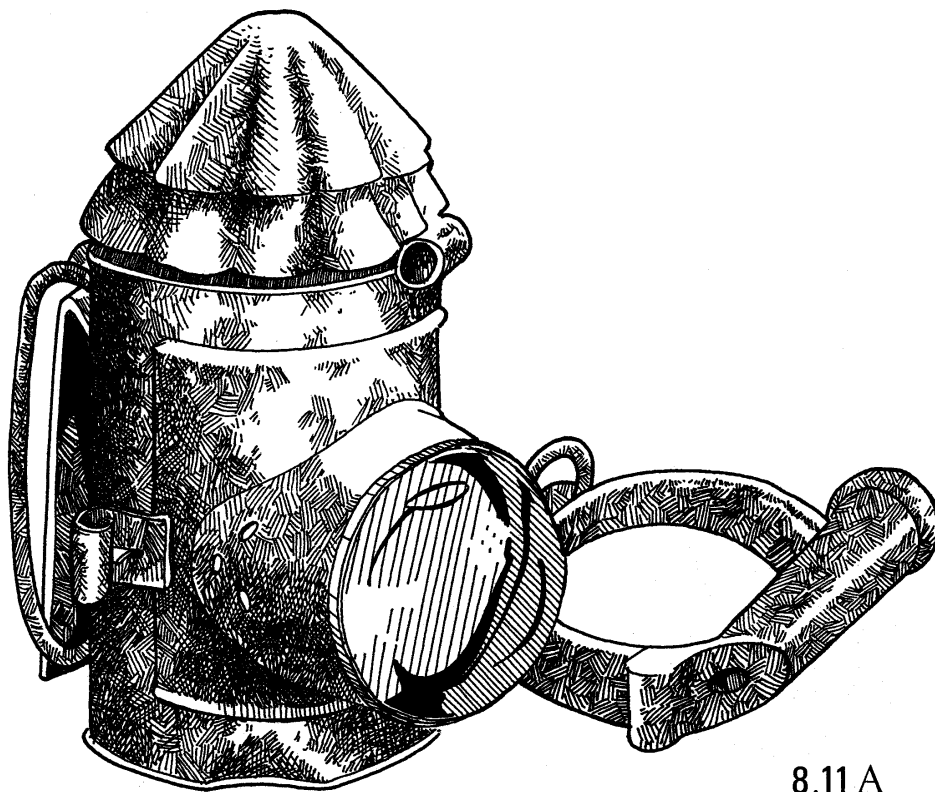

8.11 A

8-186A VICTORIAN TOYS & GAMES ☺

Doll (mid-19th-century)
 Gyrograph
 Tops
 Diabolo
 Wooden soldier
 Maze
 Board game
 Jumping Jack
 Notes

8-184A VICTORIAN EDUCATIONAL GAMES ☺

Alphabet frieze (1883)
 Animal alphabet game
 Slate
 British Sovereigns Game
 Ivory letters
 History card game
 Cross-stitch sampler
 Bone letters of the alphabet
 Dick Whittington play
 Reading, story & music books
 Notes

8-126A(1,2,3) VICTORIAN TOY CIRUCS ☺

14 jointed wooden animals
 Circus equipment

8-66B VICTORIAN JIG-SAW PUZZLE

Jig-saw puzzle 'The Great Exhibition' displayed under Perspex on panel
 37 cm x 30 cm

8-225A STEREOSCOPIC VIEWER

Stereoscopic viewer
 Three cards (l.w. views)
 Notes

8-275A ZOETROPE ☺

Zoetrope (small reproduction)
 Picture strips
 Notes

8-173A ALPHABET BLOCKS

Wood blocks each with a letter and appropriate illustration (20)

8-321A HOOP (child's reproduction)

8-322A HOOP (child's) "

10-319A TRADITIONAL TOYS & GAMES

Whip and top (reproduction)
 Cup & ball game "
 Spinning top "
 Diabolo "
 Notes

10-214A TRADITIONAL TOYS & GAMES

Diabolo (reproduction)
 Cup and ball "
 Spinning top "
 Whip and top "
 Notes

8-126A

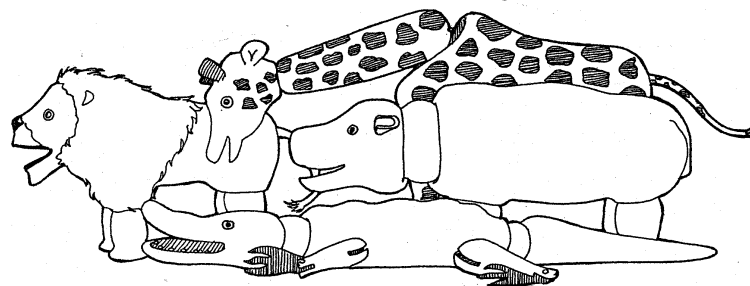

8-71B SAMPLER (1856)

Sampler displayed under perspex
on panel 36 cm x 32 cm

8-220A SET OF SLATES

30 slates (for class use)
Slate pencils

8-288A SET OF SLATES

30 slates (for class use)
Slate pencils

8-270A ABACUS

School abacus (on stand)

8-271A ABACUS

School abacus (on stand)

8-272A ABACUS

School abacus (stand missing)

8-309A WRITING ☺

Pewter inkwell
Quill pen
Notepaper
Notes

8-205A WRITING ☺

Sheet of Victorian notepaper
Envelope, dated 1836
Quill pen (modern)
Steel-nib pen with wooden holder
Pen-knife
Ruler
Letter scales
Stamp box
Letter opener with seal in handle
Notes

8-206A WRITING ☺

Victorian inkstand with stag's head decoration
Queen Victoria marble paper-weight
Brown stoneware ink bottle

8-240A STAPLER ☺

19th-century stapler
Notes

8-199C VICTORIAN POSTMAN

Costume model

8-257A SCRIBE'S CASE ☺

Brass case for pens and ink
(from Far East)
Notes

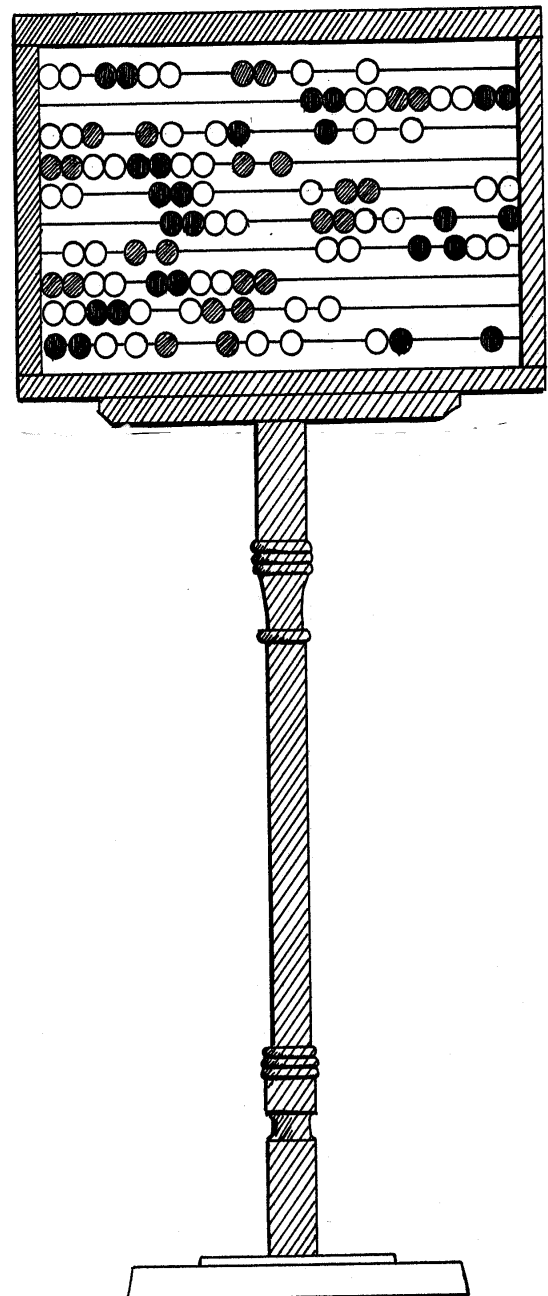

Victorians

8-219A VICTORIAN MISCELLANY ☺

Glove stretcher
Scotch hands
Powder box
Sugar nippers
Inhaler
Moustache curler
Mourning handkerchief
Tin- opener
Button hook
Notes

8-286A VICTORIAN MYSTERY OBJECTS ☺

Glove stretcher
Bath thermometer
Ruler
Hand cooler
Button hook
Egg topper
Skirt lifter
Notes

8-376A FLORENCE NIGHTINGALE
Turkish lantern (reproduction)
Scutari brassard "
Notes

8-400A VICTORIAN/EDWARDIAN
BOTTLES & JARS
2 stoneware jars
5 stoneware bottles
6 glass bottles
Books - International Bottle
Collectors' Guide
- The Victorian Chemist
Notes

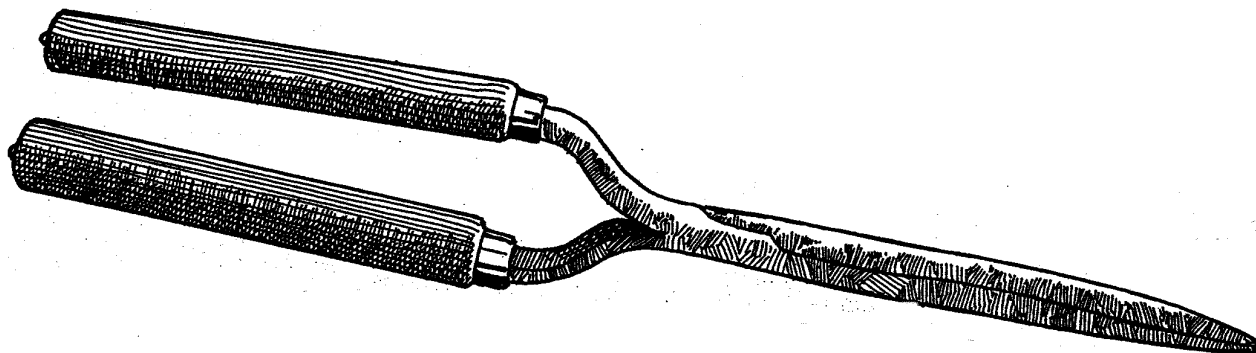

8-219A

9-122C FASHION 1905 (MAN)

Costume model

9-123C FASHION 1905 (WOMAN)

Costume model

9-265A SEED FIDDLE

Seed fiddle for broadcast sowing

Notes

**9-44A 'QUICK COOKER' PUDDING
BASIN (1910) ☺**

Basin and lid

Notes

9-226A BEAN SLICER ☺

Bean slicer

Notes

**9-183A MARMALADE CUTTER
(1930s) ☺**

Marmalade cutter (improved
version of 8-160A)

Notes

9-313A COFFEE MILL ☺

Coffee mill

Notes

9-224A LIGHTING: CANDLESTICKS ☺

Pair of glass candlesticks

Bedroom candlestick

Notes

9-210A GAS LIGHTING ☺

Wall-bracket gas light

Wall-bracket gas light with

Vitreosil shade

Gas mantle

Vitreosil shade in original packing

Notes

9-157A IRONS ☺

Gas iron

Early electric iron

Notes

9-34A STONE HOT WATER BOTTLE ☺

9-359A STONE HOT WATER BOTTLE ☺

9-222A INKSTAND ☺

Plastic inkstand

Ink wells

Notes

9-374A HOT WATER BOTTLE

9-382A DECADES – 1950S

9-383A DECADES – 1960S

9-384A DECADES – 1970S

9-385A DECADES – 1980S

9-397A DECADES – 1930s-1940s

Decade cases contain items of
Clothing

Books/magazines

China etc.

**9-399A 1930s/1940s MEDICAL
EQUIPMENT**

Stainless steel sterilizing dish

Enamel kidney dish

Invalid feeding cup

Clear glass eye wash

Syringe in s/steel case

Forceps

Catgut

Glass measuring cup

3 s/steel dishes

Safety pins

Photograph of wartime nurse

CD transcript of wartime nurse

Books

Notes

9-263A TOY MANGLE ☺

Plastic toy mangle (1950s)
Notes

9-287A TOY MANGLE ☺

Plastic toy mangle (1950S)
Notes

9-103A STEREOSCOPIC VIEWER ☺

Stereoscopic viewer
'The Underworld Travel Library':
box containing 100
stereoscopic cards
Notes

9-185A TOY BRICKS

Box of Lott's bricks
Set of 20 picture-bricks

9-339A GAMES OF THE 1920s & 30s

Table skittles
Snakes & Ladders
Rumble Tumble

9-340A GAMES OF THE 1920s & 30s

Bull board
Houp-la
Trianhole

9-344A GAMES OF THE EARLY 20TH C

Lotto
Solitaire
Table croquet
Patience playing-cards

9-343A WHEELED TOYS

1930s straw-filled duck
1930s wooden pull-along horse
with rider
Train
Model cannon
1960s plastic sports car
Six small wheeled vehicles

9-380A TOY MANGLE

Notes

9-381A SOFT TOYS

2 soft toys of 1940s

9-345A LEAD TOYS

Farm set
Garden set

9-350A TOY SEWING MACHINES

Two children's sewing machines

9-351A STRING PUPPETS ☺

Elephant
Tiger

9--320A STRING PUPPETS ☺

Boy
Dog

9-323A MOVING TOYS

Walking poodle
Rocking clown
Pecking hens
Pop-out bird
Pull-along chicks

9-357A CLOCKWORK TOYS

Mouse
Robin
Dancing clown
Train
Mouse (reproduction)
Bird "
Notes

9-358A JOINTED TOYS

Press-base dog
Jointed acrobat
Metal pecking hens
Jointed acrobat (modern)
Press-base donkey "
Notes

9-372A COMPOSITION DOLL

1930s doll

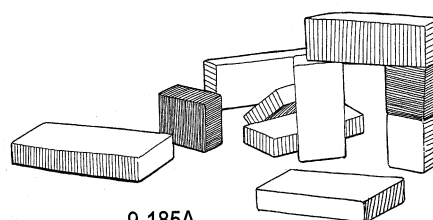

9-185A

9-250A WORLD WAR 1

Sam Browne (army officer's belt)
Tin of tobacco
Two postcards
Ration-card folder (with cards)
Notes

9-159A WW 2: GAS MASK

Heavy-duty respirator in haversack

9-209A WW 2: CIVIL DEFENCE

Civilian-duty respirator
Civil Defence armband
Fire Guard's helmet
Eyeshield, throatbrush
Householder's First Aid case
Various books & instructions
Notes

9-172A WW 2: BABY'S GAS MASK

9-262A WW 2: BABY'S GAS MASK

9-259A WW2: ARMY FOLDING SAW

Saw & notes

**9-163A(1,2) WW 2: GAS THREAT
(anti-contamination out-fit)**

Cloak, trousers, shirt
Helmet, goggles
Notes

9-348A (1,2,3) WORLD WAR 2: FIRE

Bucket, stirrup pump
Helmet, arm band, eye shield
Hand-books & leaflets
Notes

9-349A WW2: GAS ATTACK

Gas rattle
Gas mask
Anti-dim cloth in tin
Eye shield in sleeve
Anti-gas ointment tubes & tin
Remedy for poisonous gas & tin
Book & leaflets
Notes

9-399A 1930/1940s MEDICAL EQUIP.

See page 27 for items

9-162A WW 2: AIR RAID PRECAUTIONS

First Aid Post helmet
Fire Guard helmet
ARP Warden's whistle

9-341A WW 2: HOME LIFE

Gas mask
Pair of ladies' & men's shoes
Pair of glasses
Blackout curtain
Various books & leaflets
Notes

9-342A WW2: HOME LIFE

Gas mask
Pair of ladies & men's shoes
Blackout torch
Blackout curtain
Various books & leaflets
Notes

9-386A WW2 FOOD RATION

9-387A WW2 FOOD RATION

Replica food showing one
weeks food ration

9-388A REPRODUCTION GAS MASKS

9-389A REPRODUCTION GAS MASKS

5 gas masks that can be tried on

9-391A EVACUEE'S CASE

Rag doll
Clothing
Book

9-392A ANTI-GAS LEGGINGS

Gas rattle
ARP Handbook No.2
Notes

9-393A WOMEN IN WW2

Boots, uniform, hand bag
Notes

9-394A ARP UNIFORM & HELMET

Helmet
Jacket
Trousers
Notes

Miscellaneous

10-230A GENERAL COLLECTION ☺

Tea-strainer & tray
Vacuum flask
Hole punch
Toothbrush
Table knife
Table fork
Jelly mould
Notes

10-292A GENERAL COLLECTION ☺

Hot water bottle
Candle holder
Patty tin
Money box
Flat-iron
Pencil case
Pair of gloves
Baby's bonnet
Notes

10-255A PAIRS OF OBJECTS ☺

Stone-Age flint knife
Bone-handled knife
School reading book (1930s)
Two different clothes-pegs
Quill pen
Steel-nib pen
Two different tin-openers
Two old pennies, different dates
Tudor horn book (replica) Notes

Vacuum flask
Purse
Flat-iron
Money box
Bone-handled knife
Kid glove
Notes

10-204A GENERAL COLLECTION ☺ (Objects through time)

Old Stone-Age flint hand-axe
Beads from Ur
Four Roman tesserae
Stone cannon ball
Fragment of Tudor dish
Shoe horn
'Old' money: 1904 penny
1967 half-penny
Money box
Souvenir mug of Princess
Elizabeth & Princess Margaret
Notes

10-218A GENERAL COLLECTION ☺ (Objects through history)

Hand-axe (prehistoric)
Oil lamp (Roman)
Brooch (Anglo-Saxon) (repro)
Coin (Medieval) (repro)
Seal of Elizabeth I (Tudor) (repro)
Royalist badge (Stuart) (repro)
Brass snuffers (Georgian)
Silk bookmark (Victorian)
Reading book (20th-century)
Nine period cards
Notes

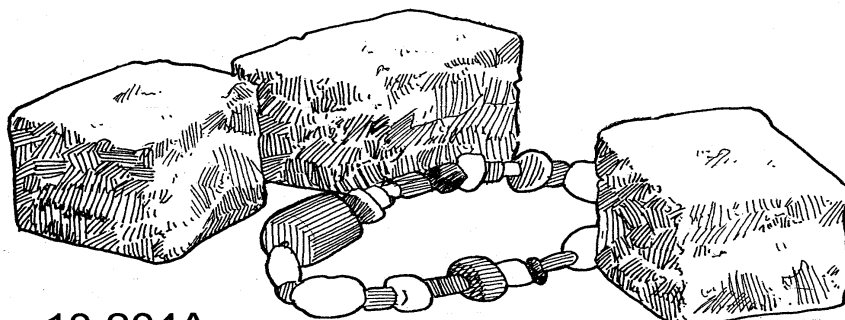

10-204A

10-208A DATED COLLECTION

(These objects are all dated)
Great Seal of England 1651
(reproduction)
Copy of The Times 1805
(facsimile)
Envelope 1836
Printer's block of an election
leaflet 1847
Queen Victoria's Golden Jubilee
medal 1897
Souvenir leaflet of George V's
Silver Jubilee 1835
Royal Wedding mug 1981
Coins
Notes

10-246A MYSTERY OBJECTS ☺

(mostly 19th- century)
Scotch hands
Window knocker
Needle case?
Button cleaner
Curling tongs
Watch stand
Tongue- scraper?
Hat- pin holder?
Hat- pin
Notes

10-249A MYSTERY OBJECTS

Italian iron
Trivet
Loaf- sugar cutter
Mantle- hanging
Modesty vest
Massage roller
Notes

10-297A SHOE COLLECTION ☺

11 pairs of shoes
Worksheets
Notes

10-315A SHOE COLLECTION ☺

11 pairs of shoes
Worksheets
Notes

10-346A SHOE COLLECTION ☺

(This collection is for display
only)
Nine pairs of shoes
Notes

10-347A SHOE COLLECTION ☺

(This collection is for display
only)
Nine pairs of shoes
Notes

10-317A SHOE ACCESSORIES ☺

Measuring gauge
Various shoe- trees

10-318A ELVES & THE SHOE MAKER☺

Six copies of the book

10-325A HATS ☺

16 assorted hats
Worksheets

10-334A MONEY ☺

Telephone money box
Shop scoop
Penny bank
Victorian handbag
5 purses
Decimal adder
Magic Pocket Savings Bank
Sovereign Balance
Currency Calculator
£1 note
1937 cheque
Guide to decimal
currency (booklet)
'Force' catalogue
Penn Ltd catalogue
International Stores catalogue
Selection of coins
Notes

10-360A AFRICAN STOOLS ☺

Two carved wooden stools
Notes

10-115A FIRE

Fire bucket
Fire marks
Notes

Miscellaneous

10-319A TRADITIONAL TOYS & GAMES

Whip and top (reproduction) ☺
Cup & ball game "
Spinning top "
Diabolo "
Notes

10-214A TRADITIONAL TOYS & GAMES

Diabolo (reproduction) ☺
Cup and ball "
Spinning top "
Whip and top "
Notes

8-321A HOOP (child's) (reproduction)

8-322A HOOP (child's) (reproduction)

10-324A GAMES ☺

Seven wooden skittles & ball
Dominoes
Flip-a-ring-O & six rings
Solitaire board & marbles

10-316A NURSERY RHYME CASE ☺

Toasting fork
Sheep shears
Enamel candleholder
Child's washboard
Dressing-up clothes (Bo-Peep)
Man's nightshirt
Sheep's wool
Horseshoe
Lucy Locket's pockets (repro)

10-332A GARDENING

Edging tool
Watering can
Two types of weeder
Notes

10-326A FARMING

Billhook
Turnip knife
Sheep shears
Bullock-holder
Bird-scarer (reproduction)
Notes

10-327A THE DAIRY ☺

Milk measure
Stoneware butter stamp
Scotch hands
Skimmer (reproduction)
Notes

10-260A FARMING ☺

Billhook
Sheep shears
Animal-feed scoop
Notes

10-117A FARMING

Shepherd's crook
Victorian sheep shears
Cream skimmer
Scotch hands
Horn beaker

10-329A LIGHTING ☺

Small lantern (reproduction)
Stable lantern "

10-336A LIGHTING

Enamel candleholder
Slate candlesticks
Candlestick with height-adjuster
Brass snuffers & tray
Rushlight (reproduction)
Notes

10-370A SEASIDE: SOUVENIRS

Pressed seaweed in album
Souvenir saucer
Sand picture
Oyster shell
Collection of shells & fossils
Photograph, book extract, notes

10-377A SEASIDE: CLOTHING ☺

Parasol (reproduction)
Sailor suit & sun bonnet
2 swimming costumes

10-379A PUNCH & JUDY ☺

Two puppets
Two books: Fun & Games;
The Smith Family at the
Seaside

**10-398A Solent & Wight
Maritime Archaeology
& Maritime Aggregates**

Teaching pack info. folder

CD rom

Plastic core tube, containing
aggregate

Real artefacts:

White plate

Shell case

Clay pipe

Pieces of pottery

Flint hand axe

Fake flint hand axe

Reconstructed artefacts:

Bone dice

Leather wrist guard

Metal arrow head

Wooden bleeding bowl

Bone needle

